

Oxygen Concentrator

7F-5A

User's manual

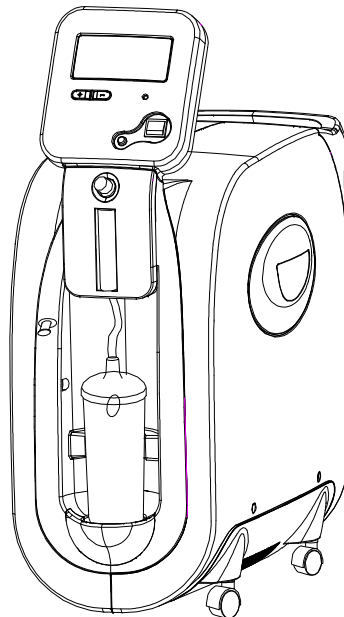

TABLE OF CONTENTS

SAFETY NOTES.....	2-5
FEATURES.....	6-7
HANDLING.....	8
OPERATING & INSTALLATION.....	9-14
MAINTENANCE.....	15-20
DISASSEMBLY.....	21-23
OTHER ATTENTION ITEMS.....	24-25

**DO NOT OPERATE THIS UNIT WITHOUT FIRST
READING AND UNDERSTANDING THIS MANUAL**

SAFETY NOTES

WARNING: For avoiding power outage or oxygen concentrator operating failure, exigent oxygen user and serious patient must equip with reserve oxygen supply (for example: oxygen cylinder, oxygen bag). This device is to be used as an oxygen supplement and is not considered life supporting or life sustaining.

I . BEFORE INSTALLATION

- The concentrator should always be kept in the upright to prevent cabinet damage while being transported.
- Electrical source, power voltage is instable that beyond normal power voltage range. Please add manostat.
- Use eligible, safe power set and junction box.
- Curbstone people do not open oxygen concentrator's cabinet.

II . PUT POSITION

- You may select a room in your house where using your oxygen concentrator would be most convenient. Your concentrator can be easily rolled from room to room on its casters.
- Be certain to place the unit so all sides are at least 10cm (4inches) away from walls, draperies, furniture, or other obstruction. Do not place the unit in a confined area.
- Oxygen concentrator must avoid heat source, fire source, wetness, exorbitant or over-low extraventricular condition.
- Sundries and vessel do not be placed on top of the concentrator.
- NEVER block the air openings of the unit or place it on a soft surface, such as a bed or couch, where the air opening may be

SAFETY NOTES

blocked. Keep the openings free from lint, hair and the like.

III. USING

- The use of oxygen therapy requires that special care be taken to reduce the risk of fire. Users **MUST NOT SMOKE** while using this device. Keep all matches, lighted cigarettes or other sources of ignition out of the room in which this product is located. **NO SMOKING** signs should be prominently displayed. Textiles and other materials that normally would not burn are easily ignited and burn with great intensity in oxygen enriched air. Failure to observe this warning can result in severe fire, property damage and cause physical injury or **DEATH**.
- For optimum performance, do not open or turn off the concentrator frequently, reset after 3~5 minutes. Shorter periods of operation may reduce maximum product life.
- A spontaneous and violent ignition may occur if oil, grease or greasy substances come in contact with oxygen under pressure. These substances **MUST** be kept away from the oxygen concentrator, tubing and connections, and all other oxygen equipment. **DO NOT** use any lubricants unless recommended by manufacturer.

IV. MAINTENANCE

The oxygen concentrator was specifically designed to minimize routine preventive maintenance at intervals of once per year. Only professionals of the healthcare field or persons fully conversant with

SAFETY NOTES

this process such as authorized or factory trained personnel should perform preventive maintenance or performance adjustments on the oxygen concentrator.

V. RADIO FREQUENCY INTERFERENCE

- Most electronic equipment is influenced by Radio Frequency Interference (RFI). CAUTION should be exercised with regard to the use of portable communications equipment in the area around such equipment.

VI. TO REDUCE THE RISK OF BURNS, ELECTROCUTION, FIRE OR INJURY TO PERSONS.

- Avoid using while bathing. If continuous usage is required by the physician's prescription:

The concentrator must be located in another room at least 2.5m from the bath.

- DO NOT come in contact with the concentrator while wet.
- DO NOT place or store product where it can drop into water or other liquid.
- DO NOT reach for product that has fallen into water. UNPLUG IMMEDIATELY.
- A product should NEVER be left unattended when plugged in.
- This device is to be used only in accordance with the prescription of a physician and this User's Manual. If at any time the patient or attendant conclude that the patient is receiving an insufficient

SAFETY NOTES

amount of oxygen, the supplier and/or physician should be contacted immediately. No adjustments should be made to the flowrate unless prescribed by a physician.

- Close supervision is necessary when this product is used near children or physically-challenged individuals.
- Use this product for only intended use as described in this manual.
- DO NOT use parts, accessories or adapters other than those authorized by manufacturer.
- DO NOT connect the concentrator in parallel or series with other oxygen concentrators or oxygen therapy devices.
- Use of some administration accessories or certain humidifiers not specified for use with oxygen concentrator may impair the performance.
- In certain circumstances oxygen therapy can be hazardous. Manufacturer recommends that you seek medical advice before using this product.
- Avoid creation of any spark near medical oxygen equipment. This includes sparks from static electricity created by any type of friction.

FEATURES

I. SUMMARY

7F-5A oxygen concentrator is intended for individual use in the home. It is an electronically operated device that separates oxygen from room air. It provides high concentration of oxygen directly to you through a nasal cannula. Clinical studies have documented that oxygen concentrators are therapeutically equivalent to other types of oxygen delivery systems.

This user's manual will tell you about your concentrator and will serve as a reference as you use your concentrator.

II. CHARACTERS

- Complete plastic out shell, safe and reliable.
- Timing turns off function using convenience.
- Exceed press safety valve helping safe ensure.
- Install power cut warning function.
- Compressor with hot protection which ensure safe of the compressor and concentrator.
- Power cord and nasal oxygen cannula etc accessories can be put in the store box of concentrator.
- ※ Having nebulizing rationale (apply in the oxygen concentrators having the function of nebulizing): May connect with nebulizer to have nebulizing cure.

III. SPECIFICATIONS

1. Flow Range: 1~5L/min 2. Oxygen Concentration: $\geq 90\%$

FEATURES

3. Maximum Outlet Pressure: 45kPa \pm 4.5kPa (6.52psi \pm 0.65psi)
4. Pressure Relief Mechanism Operational at:
250kPa \pm 25kPa (36.25psi \pm 3.63psi)
5. Altitude: Up to 1828 meters (6000 ft) above sea level without degradation of concentration levels. From 1828 meters (6000 ft) to 4000meters (13129 ft) below 90% efficiency.
6. Sound Level: ≤ 55 dB (A)
- ※ 7. Maximum Nebulization Rate (Apply in the oxygen concentrators having the function of nebulizing): ≥ 0.15 mL/min
8. Power Supply:
AC120V $\pm 10\%$ AC220V $\pm 10\%$ AC230V $\pm 10\%$
50Hz 60Hz 1.8 amps(AC220V~240V) ; 2.9 amps(AC120V)
9. Input Power: 400VA 10. Weight: 28kg (55lbs)
11. Dimension:
H71.2cm \times W28.5cm \times D54.5cm
12. Minimum Operating Time: 30minutes
- Electric classification: II class ,type B applied part.
- Work system: work continuously.
- Keep it far from flammable and explosive gas area.

IV. NORMAL OPERATION CONDITIONS

- Temperature range: 5 $^{\circ}$ C~40 $^{\circ}$ C
- Relative humidity: $\leq 80\%$
- Atmosphere pressure: 86kPa~106kPa (12.47psi~15.37psi)

HANDLING

I. UNPACKING

- Check for any obvious damage to the carton or its contents. If damage is evident, please notify the carrier or local dealer.
- Remove all loose packing from the carton.
- Carefully remove all the components from the carton.

NOTE: Unless the oxygen concentrator is to be used immediately, retain containers and packing materials for storage until use of the concentrator is required.

II. INSPECTION

Examine exterior of the oxygen concentrator for nicks, dents, scratches or other damages. Inspect all components.

III. STORAGE

- Store the repackaged oxygen concentrator in a dry area.
- DO NOT place other objects on top of the repackaged concentrator.

IV. OPEN UP THE PANEL

Pry out the shaft with the special tool as follows, then lift up the display panel for about 45 degree, put the shaft back, fix the display panel, and the machine can be used.(Figure 1)

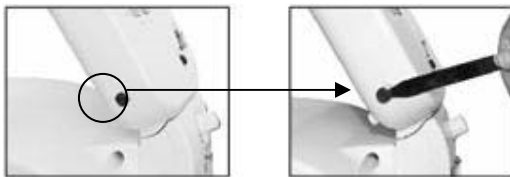

Figure 1

OPERATING & INSTALLATION

I. FEATURE VIEW

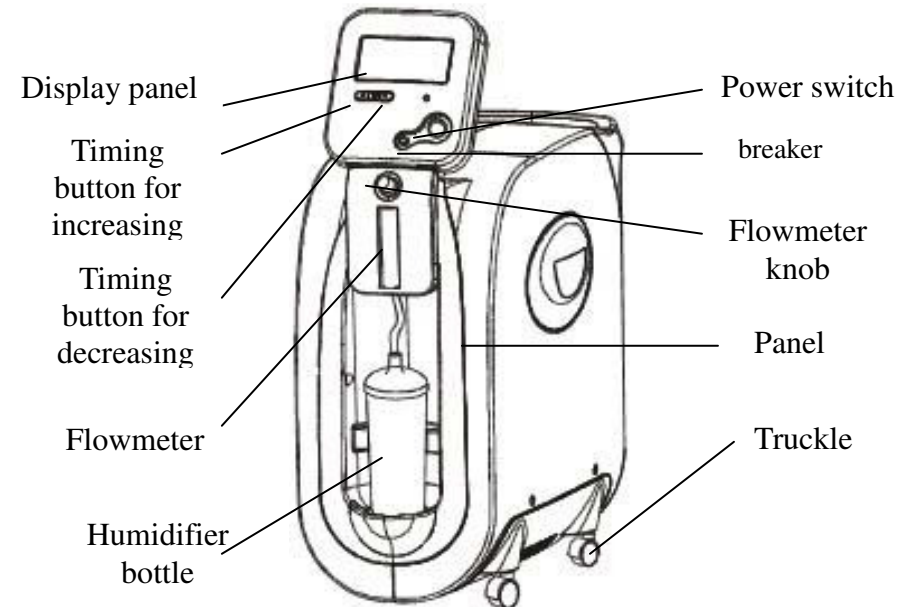

Figure 2: view of the humidifier

OPERATING & INSTALLATION

II. PREPARE WORK

1. Unscrew the bottle from the humidifier clockwise. Fill the bottle with pure water (or distilled water) to the level indicated by the manufacturer.

DO NOT OVERFILL humidifier bottle. (Figure 3)

2. Screw securely the bottle back counterclockwise.
3. Connect the power supply.

WARNING:

- 1) If the concentrator has a damaged cord or plug, if it is not working properly, if it has been dropped or damaged, or dropped into liquid, call Qualified Service Personnel for examination and repair.
 - 2) Keep the cord away from HEATED or HOT surfaces.
 - 3) Do not move or relocate concentrator by pulling on the cord.
 - 4) Do not use extension cords with this unit.
4. Press down the power switch while the display shows elapsed time and “— —”. After a few seconds, the concentrator will work.
- NOTE: Concentrator may be used during the initial start warm-up time (approximately 30 min) while waiting for the O₂ purity to reach maximum.



Figure 3

OPERATING & INSTALLATION

III. OXYGEN ABSORBING OPERATION

1. FLOWRATE (Figure 4)

- Turn the flowrate knob to the setting prescribed by your physician or therapist.

NOTE: To properly read the flowmeter, locate the prescribed flowrate line on the flowmeter.

Next, turn the flow knob until the ball rises to the line. Now, center the ball on the L/min line prescribed.

CAUTION: If the flowrate on the flowmeter ever falls below 0.5L/min, check tubing or accessories for blocked or kinked tubing or a defective humidifier bottle.

- Meanwhile, humidifier bottle will have air bubble around the sieve core. Then, oxygen comes from the oxygen outlet.
2. Connect nasal oxygen cannula to oxygen outlet, the other end match the patient.

Note: The time of absorbing oxygen and the flowrate range according to the doctor's advices.

※ IV .NEBULIZING OPERATION (Apply in the oxygen concentrators having the function of nebulizing.)

- Fill proper medicinal liquid in the nebulizing cup (Please follow the doctor's advices or don't exceed the maximum reticle of the

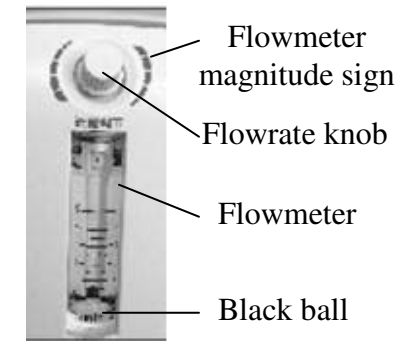

Figure 4

OPERATING & INSTALLATION

nebulizing cup).

- Upward pull out the nebulizing cover on the nebulizing interface. (Figure 5)

Figure 5

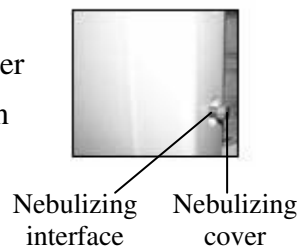

- Connect the air hose to nebulizing cup and nebulizing interface, then turn on the power of the oxygen concentrator, now can begin nebulizing cure immediately.
- When drug nebulization have finished, turn the nebulizing cover right to nebulizing interface for tightening. If you won't breathe oxygen, please turn off the oxygen concentration.

- Pull out the air hose, pull the mouthpiece, downward pull the nebulizing cup's cap, empty remained medicinal liquid in the nebulizing cup, then wash the air hose, mouthpiece, nebulizing cup's cap, nebulizing baffle, nebulizing cup, ripple tube, T-piece, etc, with pure water or immerse them in warm water for about 15 minutes. In order to wash them healthy, you may add some vinegar in water. (NOTE: DO NOT cook the accessories above for wash or wash them with boiled water, in case they'll distort when heating).
- After finishing washing you must dry all the accessories before storing. (Nebulizing installment is shown in figure 6).

NOTE: the time for nebulizing should follow the doctor's advices.

OPERATING & INSTALLATION

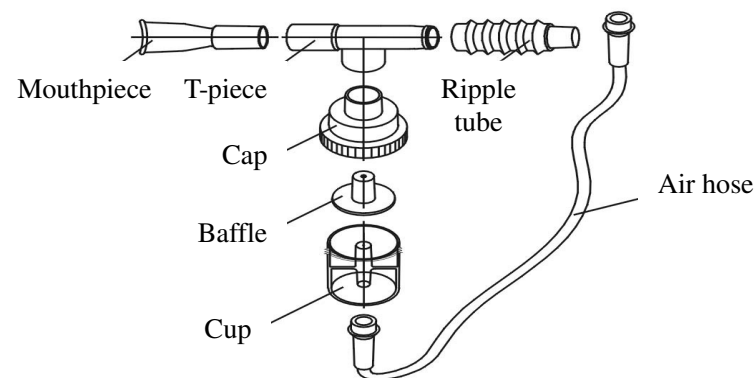

Figure 6

V. SETTING TIMING UP

User can press the timing button in 00-99 minutes.





- When it start working "--"shows on display, it says timing function not open. It will work continually until power supply cuts off.
- Press the "+"button once, operation time increases one minute, holding the button more than 1.5 seconds it will increase continually.
- Press the "-"button once, operation time decrease one minute, holding the button more than 1.5 seconds it will decrease continually.
- It will auto turn off when finishing timing meanwhile "00" show on display. Reset timing function.

OPERATING & INSTALLATION

VI. TURNING OFF

Take off nasal oxygen cannula from oxygen outlet first, close power switch, and then cut off power source.

VII. SYMBOLS

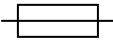
Symbol	Description	Symbol	Description
~	Alternating current		Consult the manual
	Class II Equipment		Type B applied part
	OFF(power. disconnection from the mains)		ON(power. connection to the mains)
	breaker		

MAINTENANCE

NOTE: Power should be disconnected before beginning preventive maintenance on the concentrator. The concentrator is specifically designed to minimize routine preventive maintenance at intervals of once per year. In places with high dust or soot levels, maintenance may need to be performed more often. The following must be performed at a minimum of one year in service to assure years of additional reliability.

I . CLEANING CABINET

WARNING: CUT OFF the power supply first. To avoid electrical shock, DO NOT removes cabinet.

Clean the cabinet with a mild household cleaner and non-abrasive cloth or sponge at least one time each month.

II . CLEANING OR REPLACING FILTERS

Please clean and replace the filters in time, it's very important to protect compressor and delay machine's life.

CAUTION: DO NOT operate the concentrator without the filters installed.

● Disassembly

(1) The first mesh in filter cleans once half a month. (Figure 7)

II-stage filter door

I-stage filter mesh

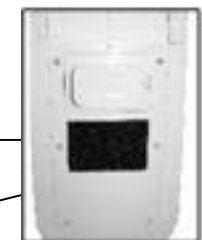
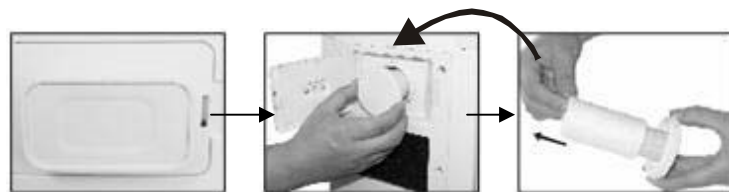

Figure 7

MAINTENANCE

Figure 8



(2) II-stage filter mesh in filtrater cleans once month. (Figure 8)

Open filter access door;

Unscrew the filter corn;

II-stage filter mesh cleaning time depends on practically using and condition. If the filter core becomes black, please replace or clean it at once, no matter how long it used.

● Cleaning

- 1) Clean the filters with a vacuum cleaner or wash in warm soapy water and rinse thoroughly.
- 2) DRY the filters thoroughly before reinstallation.

Damage: Do not operate the concentrator without the filters installed, or while filters are wet. These actions could permanently damage the concentrator.

MAINTENANCE

III. TROUBLESHOOTING GUIDE

Symptom	Probable cause	Solution	Remark
Press the switch, the concentrator is alarm of continuous buzzer but no display and working.	1) Power cord NOT plugged In.	1) Insert the power cord	
	2) No power outlet.	2) Use normal power.	
	3) Reset switch open.	3) Press it.	
	4) Down-lead plug-in of the transformer loose	4) Check and fasten it.	Repairs by qualified personnel.
	5) The transformer is broken.	5) Replace it.	
Concentrator is working, the turning sound of assemble valve is weak and the flowmeter can turn down but can't turn up at a certain value.	1) I-stage filter blocked.	1) Clean or replace it.	
	2) II-stage filter blocked.	2) Clean or replace it.	
	3) Insufficient power at outlet.	3) Do not use extension cords. Move to another electrical outlet or circuit.	
	4) The air intake of compressor kinked.	4) Smooth them.	Repairs by qualified personnel.
	5) Pressure relief valve of compressor leaked gas.	5) Repair or replace the valve.	
	6) Tube on the sieve bed leaked gas.	6) Tighten it.	
	7) Insufficient air exchanging of assemble valve.	7) Replace the valve.	
	8) Failure of electronic control circuit.	8) Repair or replace it.	
Concentrator is working with a sound of phut-phut, and the ball in the flowmeter located on "0" position or float unstable.	1) Failure of pilot valve.	1) Repair or replace it.	Repairs by qualified personnel.
	2) Failure of assemble valve.	2) Replace it.	
	3) Failure of electronic control circuit board.	3) Repair or replace it.	

MAINTENANCE

Symptom	Probable cause	Solution	Remark
Concentrator is working, but oxygen from outlet is little or no.	1) Humidifier leaked.	1) Reinstall and tighten it.	
	2) Safety valve of humidifier opens.	2) Safety valve restoration.	
	3) The nasal cannula kinked or blocked.	3) Replace it.	
Concentrator is working with normal sound, but flowmeter can turn down but can't turn down at a certain value.	1) The nasal cannula folded or blocked.	1) Smooth it.	
	2) The filter corn in humidifier bottle blocked.	2) Clean or replace the corn.	
Concentrator is working with normal sound, but flowmeter's display is "0" and can't turn up.	1) The air intake of flowmeter is loose.	1) Tighten it.	
	2) Flowmeter has fault.	2) Replace it.	
	3) The pressure regulator ruptured or blocked.	3) Replace it.	
Concentrator is working with normal sound, but the display has no display or appears disorderly code.	1) The connect line of display is loose.	1) Tighten the connecting line.	
	2) The connect line of display' is broken.	2) Replace the connect line.	
	3) Display circuit board has fault.	3) Replace it.	
Press the switch, displaying is normal, but compressing pump/fan can't work.	1) Turning on/off the machine too frequently makes it breakdown.	1) Operate the concentrator after turning off 3 ~ 5 minutes.	
	2) The main controlling circuit board has fault	2) Replace the main controlling circuit board.	

MAINTENANCE

Symptom	Probable cause	Solution	Remark
The nasal cannula has more mirage or blobs.	1) It's not ventilate completely around machine, so operating temperature is too high.	1) Make sure the machine is at least 10 cm away from the walls, other jam or heater.	
	2) Temperature of the water added in humidifier bottle is overhigh.	2) Add cold water in bottle, but don't add overhot water.	
	3) The water added in humidifier bottle is too much.	3) Water added should between the maximum and minimum of the water curve.	
	4) The machine stops suddenly during breathing oxygen.	4) Stop breathing oxygen immediately. Restart the machine to eject the hydrosphere.	
	5) The machine stops suddenly when folding the nasal cannula.	5) Smooth the nasal cannula.	
	6) Fan inside the machine can't run or running rate turns slow make the operating temperature overhigh.	6)a. Take out the eyewinker that lock the fan. 6) b. Replace it.	Repairs by qualified personnel.

MAINTENANCE

Symptom	Probable cause	Solution	Remark
※ The nebulizer doesn't run.	1) Check nebulizer is distortional or not if it was disinfected.	1) Replace it.	Apply in the oxygen concentrators having the function of nebulizing.
	2) Check air hose whether it is bended or not.	2) Ensure that it isn't bended and airflow is flowed smoothly when it is used.	
	3) Check whether medication was used up or not.	3) Add appropriate amount medication to cup.	
	4) Check the nebulizer is fixed properly or not.	4) Fix it according the method of nebulizer's fixing.	
※ Water drops have formed on the air hose.	The medication was over-filled or the nebulizer was washed.	Add appropriate amount medication to cup. Connect air hose to main body and turn on. Close and open repeatedly by finger in order to get out the water drops.	

If you have all other problems, TURN OFF the concentrator first, use your reserve oxygen supply (if provided), and contact dealer or manufacturer immediately.

DISASSEMBLY(CUT OFF the power supply first)

I .CUT OFF THE POWER SUPPLY FIRST

Put the power switch on '0',pull out the plug from the socket.

II .DISASSEMBLE THE DISPLAY PANEL

Unscrew 4 screws in the back of the display panel and take off the panel.(Figure 9)

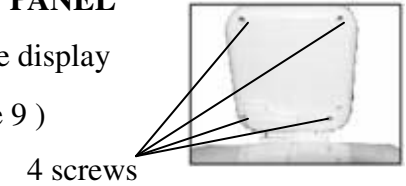

Figure 9

III. DISASSEMBLE THE OUTSIDE CABINET

1. Poke the filter door slowly from inner to outer near the orifice,unscrew the filter core.(Figure 10)

2.Unscrew 6 screws in the back cover and take off the back cover.

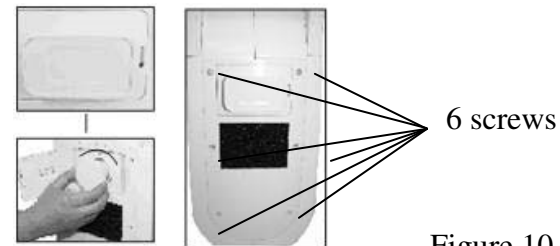
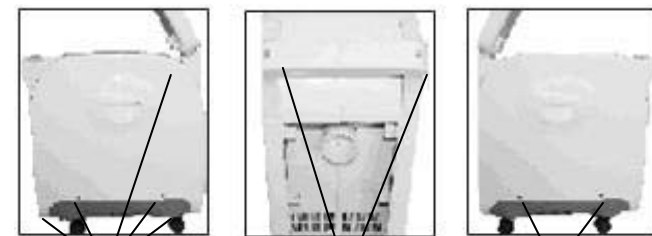

Figure 10

3.Unscrew 9 fixing screws in the left and right cabinet(5 in the left side,2 in the right side,2 in the back side)(Figure 11)



5 screws
in the left

2 screws
in the back

2 screws
in the right

Figure 11

DISASSEMBLY(CUT OFF the power supply first)

□.DISASSEMBLE THE SIDE BOARD OF THE INSIDE

CABINET

1 .Unscrew 10 fixing screws in the inside cabinet, take off the inside cabinet.(Figure 12)

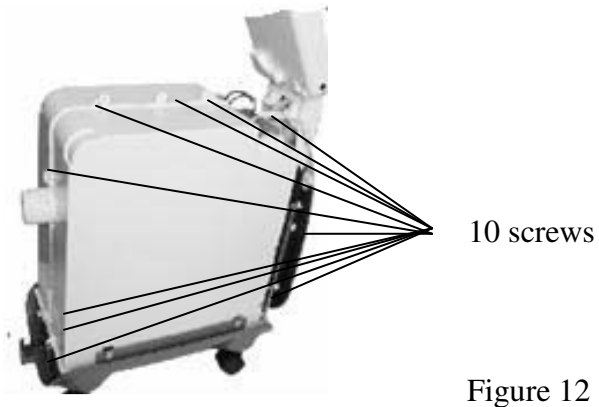

Figure 12

2.Unscrew the screws in both sides (9 screws each side) and take out it. (Figure 13, Figure 14)

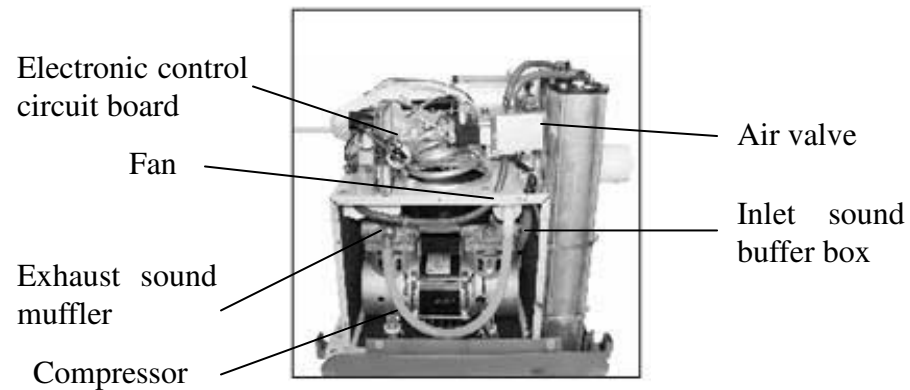

Figure 13

DISASSEMBLY(CUT OFF the power supply first)

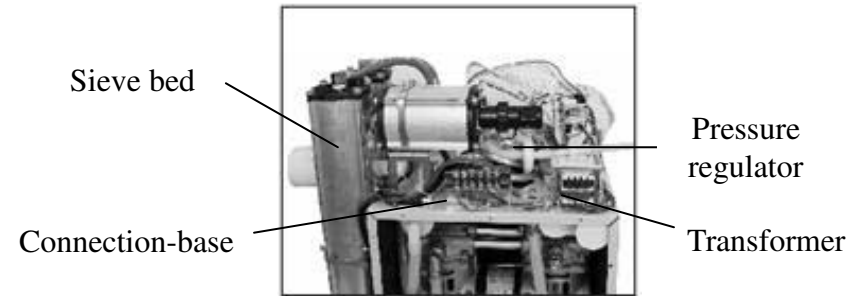

Figure 14

OTHER ATTENTION ITEMS

I. LIMITATION OF TRANSPORT AND STOCK

- Temperature range: $-40^{\circ}\text{C} \sim 70^{\circ}\text{C}$ ($-104^{\circ}\text{F} \sim 158^{\circ}\text{F}$)
- Relative humidity: $10\% \sim 100\%$
- Atmosphere pressure range: $80\text{kPa} \sim 106\text{kPa}$ ($12.47\text{psi} \sim 15.37\text{psi}$)
- Shipping weight: 31 kg

The concentrators must be stored in aeration without erode gas, avoided shaking and inversion in transport.

II. GAS PASS OPERATION SKETCH MAP

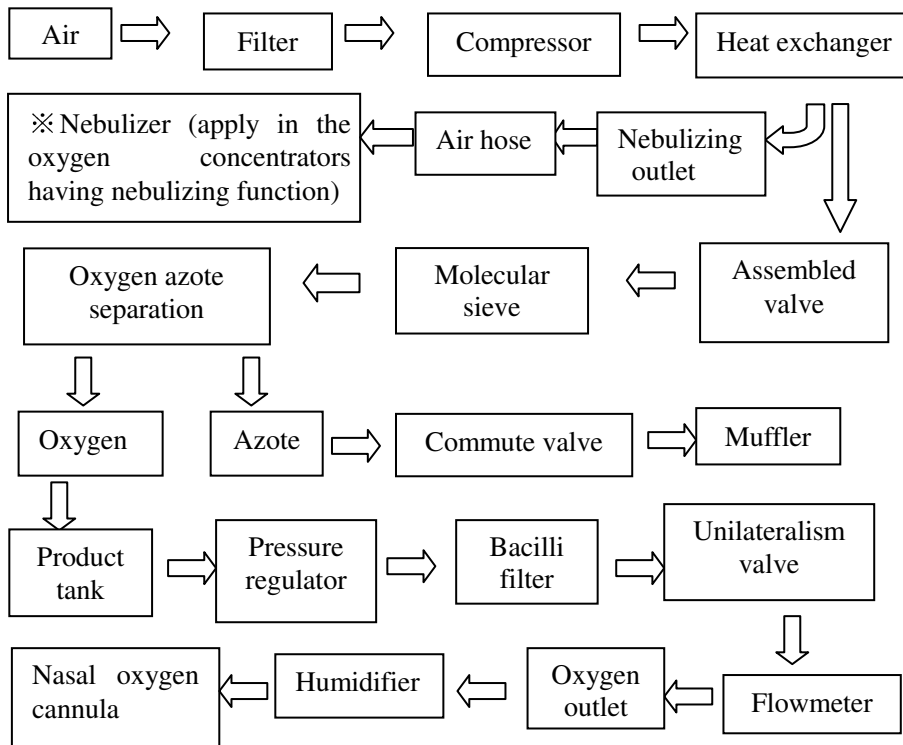

OTHER ATTENTION ITEMS

III. ELECTRICAL RATIONALE

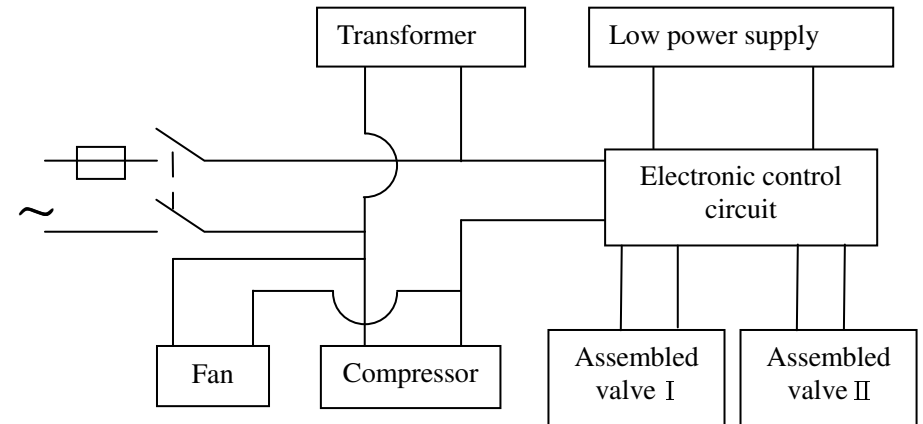

IV. ACCESSORIES LIST

1. Nasal oxygen cannula: 1 set
2. Filter core: 1 set
3. Fuse tube: each 2 pieces
4. User manual: 1 piece
- ※5. Nebulizer

(Apply in the concentrator having nebulizing function): 1 set

All specifications and product configurations are subject to change without notification.